



# Up-And-Over Garage Doors

Europe's best-selling garage door

**HÖRMANN**



### Exclusive door aesthetics

With style 905, you can create a garage front to fit your own ideas and personal architectural style. A steel frame construction for on-site infill is a solid technical basis to build on. You can pick an infill to fit your individual style. This way you can incorporate your garage door harmoniously into the overall look of your home's facade.

Styles 902 and 905 also come with a practical wicket door that provides you with good access to everything in the garage, without the need to open the entire door.

◀ Style 905 with on-site infill

◀ Style 902 Window grey RAL 7040 with wicket door

▼ Style 914 Traffic white RAL 9016



### Colours to choose

Steel doors with coloured polyester primer powder-coating. The galvanized door leaves are optimally protected against adverse effects of the weather and corrosion right up to the cut edges. Our steel styles are available in inexpensive Traffic white as standard, in 7 equally-priced preferred colours, as well as about 200 colours based on RAL.

### Collective garage doors

Up-and-over doors are also suitable for the secure locking of parking spaces in collective garages. The ventilation slots (approx. 30% of the door surface) ensure optimal ventilation.

## Steel doors

Style	902	905	914
Traffic white RAL 9016, 7 preferred colours, RAL to choose	•		•
Wicket door and side door available	•	•	
Ideal for underground and collective garages			•
Max. width (mm)	3250 (5000*)	3000 (5000*)	3000
Max. height (mm)	2750	2500	2750

\* As up-and-over garage door N500 style 405 or 402, further information can be found in the double and collective garage doors brochure



### 1 Protection against trapping

Flexible plastic rails between the door leaf and frame (no steel on steel), as well as additional protective caps over the lever arms, ensure effective protection against trapping.

Hörmann patent



### 2 Multiple spring safety system

If one of the springs breaks, the other intact springs support the door. The distance between the spring windings is so minimal that even children's fingers are protected from getting caught.



### 3 Comfortable closing

Due to the specially shaped lever arm the door pulls itself shut when closing.



### 4 Break-in-resistant due to a unique rotary catch lock

With this type of lock, the door leaf corners are fixed firmly to the frame, making forced opening practically impossible. You can additionally equip the door with top locking using an easy-to-fit retrofit kit.

Hörmann patent

Size range N 80

2750						
2625						
2500						
2375						
2250						
2125						
2000						
1875						
	2000	2250	2500	2625	3000	3250
	Door width (BRB)					

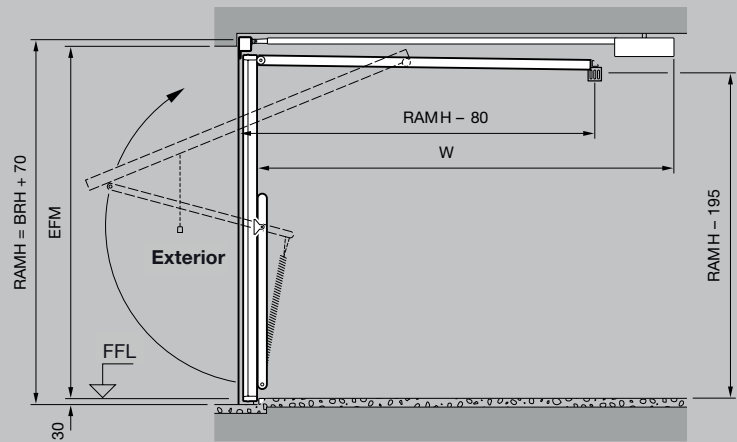

Standard sizes N 80 for single garages \*

Ordering sizes		Overall frame dimension		Clear passage dimension**		Fitting behind the opening			Fitting in the opening		
BRB	BRH	RAMB	RAMH	LDB	LDH	EFM width (EBB)	x	EFM height (EBH)	EFM width	x	EFM height
2250	1920	2355	1990	2110	1800	2250 (2215 - 2340)	x	1920 (1890 - 1950)	2375	x	1970
	2000	2355	2070	2110	1880	2250 (2215 - 2340)	x	2000 (1970 - 2030)	2375	x	2050
	2075	2355	2145	2110	1955	2250 (2215 - 2340)	x	2075 (2045 - 2105)	2375	x	2125
	2125	2355	2195	2110	2005	2250 (2215 - 2340)	x	2125 (2095 - 2155)	2375	x	2175
2375	1920	2480	1990	2235	1800	2375 (2340 - 2465)	x	1920 (1890 - 1950)	2500	x	1970
	2000	2480	2070	2235	1880	2375 (2340 - 2465)	x	2000 (1970 - 2030)	2500	x	2050
	2075	2480	2145	2235	1955	2375 (2340 - 2465)	x	2075 (2045 - 2105)	2500	x	2125
	2125	2480	2195	2235	2005	2375 (2340 - 2465)	x	2125 (2095 - 2155)	2500	x	2175
	2250	2480	2320	2235	2130	2375 (2340 - 2465)	x	2250 (2220 - 2280)	2500	x	2300
	2375	2480	2445	2235	2255	2375 (2340 - 2465)	x	2375 (2345 - 2405)	2500	x	2425
2500	1920	2605	1990	2360	1800	2500 (2465 - 2590)	x	1920 (1890 - 1950)	2625	x	1970
	2000	2605	2070	2360	1880	2500 (2465 - 2590)	x	2000 (1970 - 2030)	2625	x	2050
	2075	2605	2145	2360	1955	2500 (2465 - 2590)	x	2075 (2045 - 2105)	2625	x	2125
	2125	2605	2195	2360	2005	2500 (2465 - 2590)	x	2125 (2095 - 2155)	2625	x	2175
	2250	2605	2320	2360	2130	2500 (2465 - 2590)	x	2250 (2220 - 2280)	2625	x	2300
	2375	2605	2445	2360	2255	2500 (2465 - 2590)	x	2375 (2345 - 2405)	2625	x	2425
	2500	2605	2570	2360	2380	2500 (2465 - 2590)	x	2500 (2470 - 2530)	2625	x	2550
2625	1920	2730	1990	2360	1800	2625 (2590 - 2715)	x	1920 (1890 - 1950)	2750	x	1970
	2000	2730	2070	2360	1880	2625 (2590 - 2715)	x	2000 (1970 - 2030)	2750	x	2050
	2075	2730	2145	2360	1955	2625 (2590 - 2715)	x	2075 (2045 - 2105)	2750	x	2125
	2125	2730	2195	2360	2005	2625 (2590 - 2715)	x	2125 (2095 - 2155)	2750	x	2175
	2250	2730	2320	2360	2130	2625 (2590 - 2715)	x	2250 (2220 - 2280)	2750	x	2300
2750	1920	2855	1990	2360	1800	2750 (2715 - 2840)	x	1920 (1890 - 1950)	2875	x	1970
	2000	2855	2070	2360	1880	2750 (2715 - 2840)	x	2000 (1970 - 2030)	2875	x	2050
3000	1920	3105	1990	2360	1800	3000 (2965 - 3090)	x	1920 (1890 - 1950)	3125	x	1970
	2000	3105	2070	2360	1880	3000 (2965 - 3090)	x	2000 (1970 - 2030)	3125	x	2050

You can find up-and-over garage doors N500 up to 5000 mm width and additional door styles in the double and collective garage doors brochure

# Door type N 80 for single garages

Horizontal view Fitting behind the opening

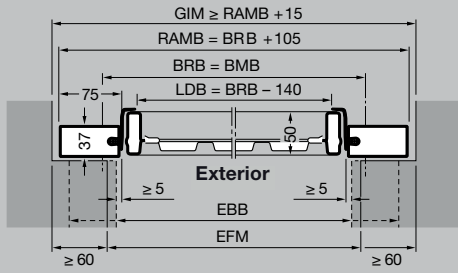

Vertical view door with threshold

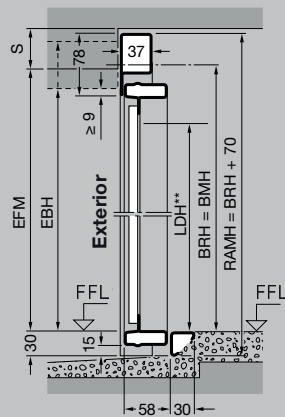

Vertical view door without threshold

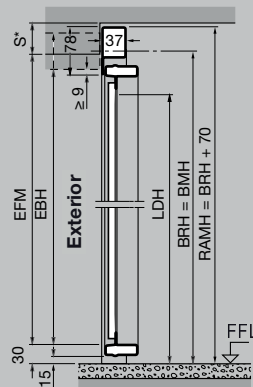

Horizontal view fitting in the opening

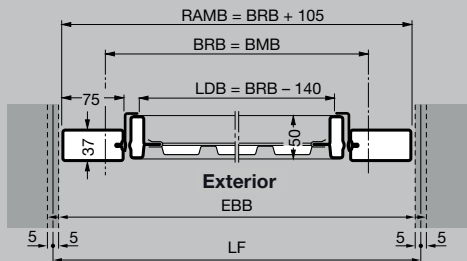

Vertical view door with threshold

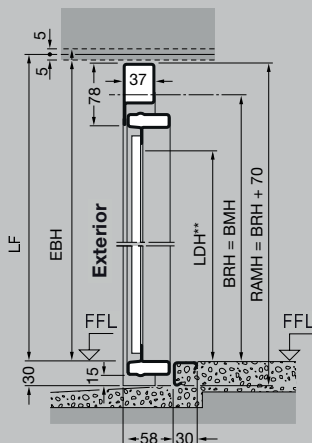

Vertical view door without threshold

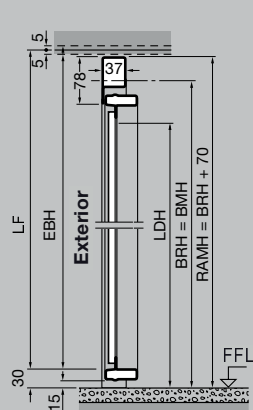

## Explanations

BMB	Ordering size width
BMH	Ordering size height
BRB	Nominal size width
BRH	Nominal size height
RAMB	Overall frame dimension width
RAMH	Overall frame dimension height
LDB	Clear passage width
LDH	Clear passage height
GIM	Inside garage dimension
EFM	Recommended structural dimension
LF	Structural opening
FM	Structural dimension
EBB	Fitting area width
EBH	Fitting area height
FFL	Finished floor level
W	Overall length of operator ProMatic / SupraMatic
	3200 mm up to 2500 mm door height
	3450 mm up to 2750 mm door height
S	Required headroom
	With steel infill ≥ 50 mm
	Style 905, 941 ≥ 65 mm
	with timber infill ≥ 65 mm

### Doors with modernisation panels

The structural width may be reduced by max. 10 mm. The structural height may be reduced by max. 10 mm if fitting with a threshold. Add 30 mm to the structural dimension for doors with uninterrupted flat floor lines (frame from FFL).

### Please note:

- \* Depending on the door style
- \*\* Clear passage dimension for doors with threshold

Standard sizes F80 for pre-fabricated garages\*

Ordering sizes		Overall frame dimension		Clear passage dimension**		Structural opening* (fitting area)		
BRB	BRH	RAMB	RAMH	LDB	LDH	Width	x	Height
2325	1905	2459	2008	2185	1785	2399-2439	x	1948-1968
2350	1935	2484	2038	2210	1815	2424-2464	x	1978-1998
2375	2045	2509	2148	2235	1925	2449-2489	x	2088-2108
2375	2075	2509	2178	2235	1955	2449-2489	x	2118-2138
2425	2075	2559	2178	2285	1955	2499-2539	x	2118-2138
2455	1905	2589	2008	2315	1785	2529-2569	x	1948-1968
2480	1935	2614	2038	2340	1815	2554-2594	x	1978-1998
2485	2045	2619	2148	2345	1925	2559-2599	x	2088-2108
2500	2075	2634	2178	2360	1955	2574-2614	x	2118-2138
2500	2100	2634	2203	2360	1980	2574-2614	x	2143-2163
2560	2125	2694	2228	2420	2005	2634-2674	x	2168-2188
2570	2125	2704	2228	2430	2005	2644-2684	x	2168-2138
2590	2075	2724	2178	2450	1955	2664-2704	x	2118-2138
2590	2125	2724	2228	2450	2005	2664-2704	x	2168-2188
2705	2125	2839	2228	2565	2005	2779-2819	x	2168-2188
2715	2075	2849	2178	2575	1955	2789-2829	x	2118-2138
2720	2200	2854	2303	2580	2080	2794-2834	x	2243-2263
2730	2125	2864	2228	2590	2005	2804-2844	x	2168-2188

Arrangement of anchors

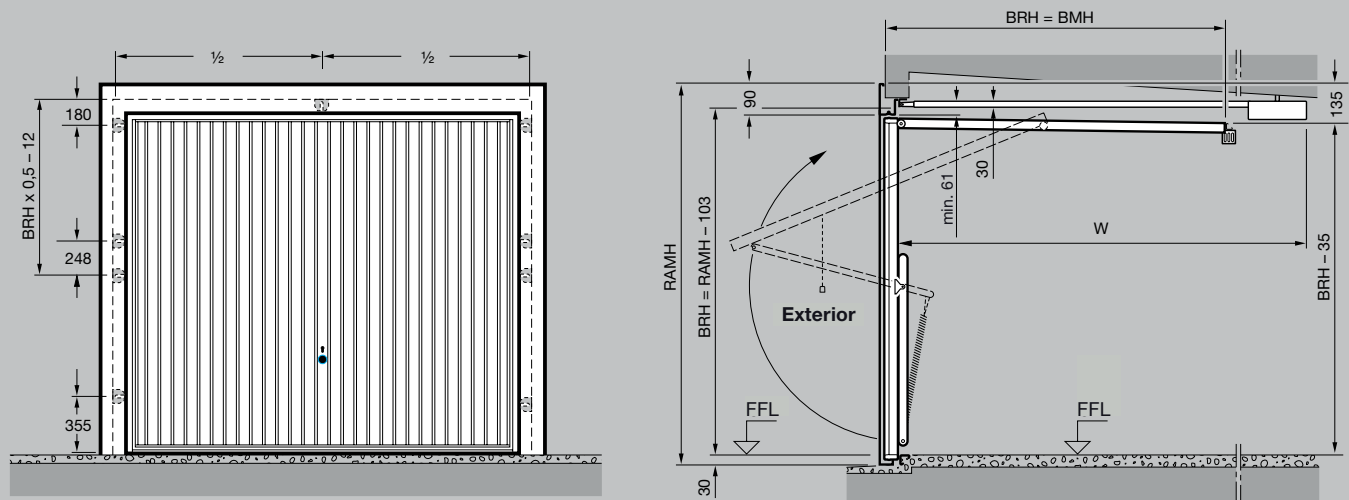

Plug-and-screw fitting

(min. 75 mm reveal depth)

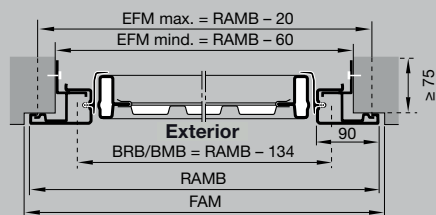

Plug-and-screw fitting with threshold

(min. 75 mm reveal depth)

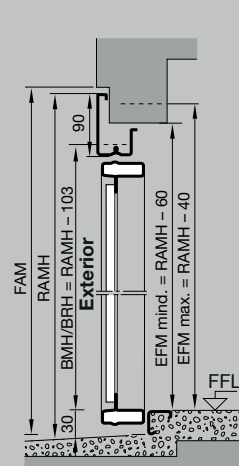

Plug-and-screw fitting without threshold

(min. 75 mm reveal depth)

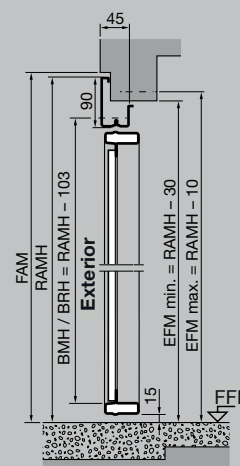

Clamp fitting without threshold

(min. 50 mm, max. 100 mm reveal depth)

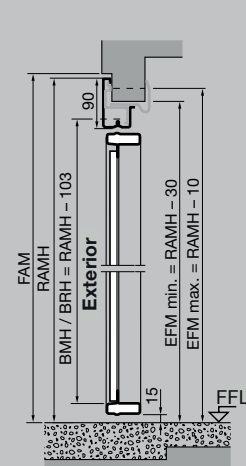

Clamp fitting

(min. 50 mm, max. 100 mm reveal depth)

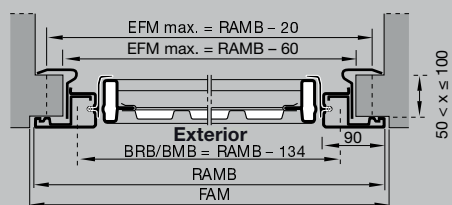

## Side door, single-leaf, with corner frame

Vertical view door without threshold

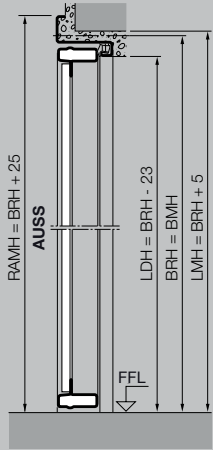

Horizontal view

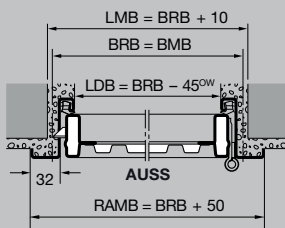

## Side door double-leaf, with corner frame

Vertical view door with threshold

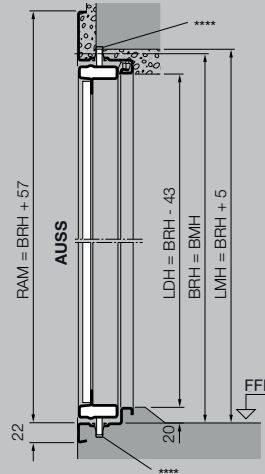

Horizontal view

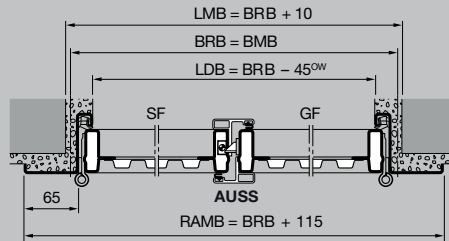

## Standard sizes for single-leaf side doors with corner frame

Ordering size		Structural opening		Clear passage dimension with threshold***		Lever height (approx.)
BRB	BRH	LMB	LMH	LDB	LDH	From FFL
875	1875	885	1880	830	1837	990
	2000	885	2005	830	1962	1050
	2125	885	2130	830	2087	1115
1000	2000	1010	2005	955	1962	1050
	2125	1010	2130	955	2087	1115

Special sizes and versions on request max. size range (BR): 1250 x 2375 mm.

Standard sizes with steel infill and on-site infill doors are supplied for external fitting as standard. Internal fitting is possible by reversing the hinges. Styles with timber infill overlapping the frame are only possible with external fitting.

## Size range for double-leaf side doors with corner frame

**Width (BRB)** 1300 to 2500 mm  
**Height (BRH)** 1750 to 2250 mm

As standard delivered for external fitting, traffic leaf on right hand side, state on order if internal fitting or traffic leaf on left hand side is required!

## Explanations

BMB	Ordering size width
BMH	Ordering size height
BRB	Nominal size width
BRH	Nominal size height
LMB	Structural opening width
LMH	Structural opening height
RAMB	Overall frame dimension width
RAMH	Overall frame dimension height
LDB	Clear passage width / clear passage width
LDH	Clear passage height / clear passage height
The clear passage width is reduced if the opening angle is less than 180°.	
W	Overall length of operator ProMatic / SupraMatic
3200 mm up to 2500 mm door height	
FFL	Finished floor level
OW	Opening angle 180°
RSL	Rain canopy
SF	Fixed leaf
GF	Traffic leaf

### Please note:

- \* Depending on the door style
- \*\* LDH for doors without threshold + 30 mm
- \*\*\* LDH for side door without threshold single-leaf + 15 mm, double-leaf + 20 mm
- \*\*\*\* Recess on location in the area of the U-shaped latching bolt

## Fitting variants side doors

### External fitting opening outwards

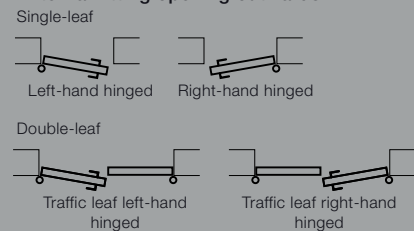

### Internal fitting opening inwards

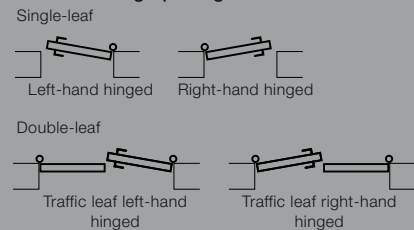

With doors fitted on the inside, the threshold angle or transport angle must always be removed and a water run-off to the outside must be provided. Doors on the weather side are preferably fitted externally.

Side door single-leaf with 65 cm block frame

Vertical view door without threshold

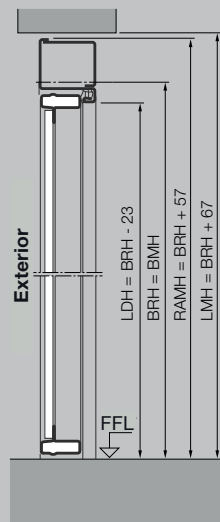

Side door double-leaf with 65 cm block frame

Vertical view door with threshold

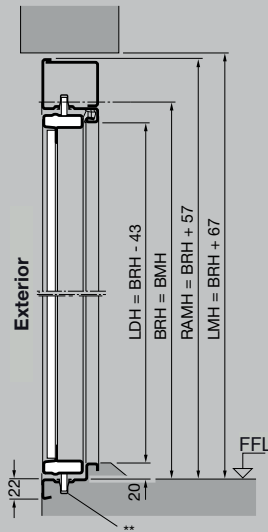

Horizontal view

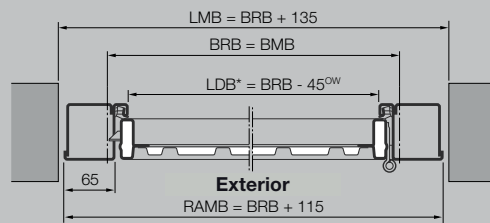

Horizontal view

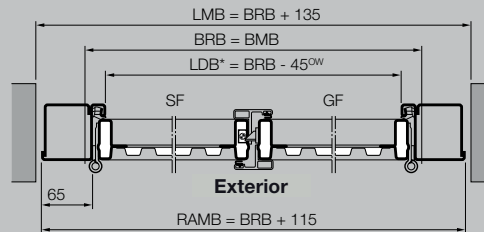

Standard sizes side door single-leaf with 65 cm block frame

Ordering size		Structural opening		Clear passage dimension with threshold*		Lever height (approx.)
BRB	BRH	LMB	LMH	LDB	LDH	From FFL
875	1875	1010	1942	830	1837	990
	2000	1010	2067	830	1962	1050
	2125	1010	2192	830	2087	1115
1000	2000	1135	2067	955	1962	1050
	2125	1135	2192	955	2087	1115

Special sizes and versions on request max. size range (BR): 1250 x 2375 mm.

Standard sizes with steel infill and on-site infill doors are supplied for external fitting as standard. Internal fitting is possible by reversing the hinges. Styles with timber infill overlapping the frame are only possible with external fitting.

Size range for double-leaf side doors with 65 cm block frame

Width (BRB) 1300 to 2500 mm  
Height (BRH) 1750 to 2250 mm

As standard delivered for external fitting, traffic leaf on right hand side, state on order if internal fitting or traffic leaf on left hand side is required!



## Side door single-leaf with 32 cm block frame

Vertical view door with threshold

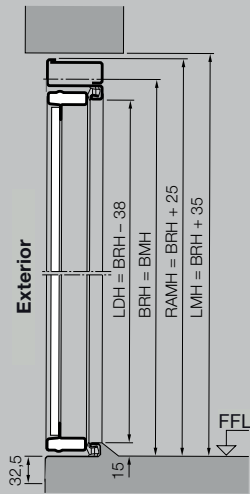

## Single-leaf side door with clamp-on frame

Vertical view door with threshold

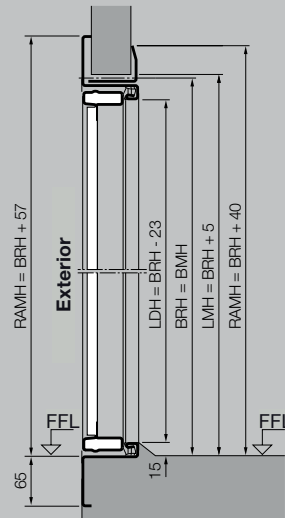

Horizontal view

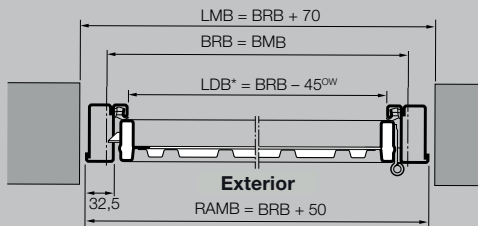

Horizontal view

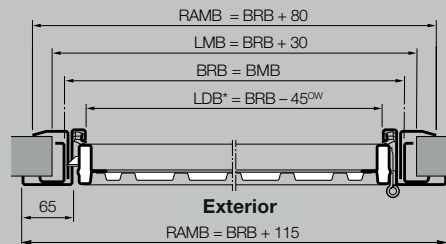

## Standard sizes side door single-leaf with 32 cm block frame / clamp-on frame

Ordering size		Structural opening		Clear passage dimension with threshold*		Lever height (approx.)
BRB	BRH	LMB	LMH	LDB	LDH	From FFL
875	1875	945	1910	830	1837	990
	2000	945	2035	830	1962	1050
	2125	945	2160	830	2087	1115
1000	2000	1070	2035	955	1962	1050
	2125	1070	2160	955	2087	1115

Special sizes and versions on request max. size range (BR): 1250 × 2375 mm.

Standard sizes with steel infill and on-site infill doors are supplied for external fitting as standard. Internal fitting is possible by reversing the hinges. Styles with timber infill overlapping the frame are only possible with external fitting.

## Explanations

- BMB Ordering size width
- BMH Ordering size height
- BRB Nominal size width
- BRH Nominal size height
- LMB Structural opening width
- LMH Structural opening height
- LDB Clear passage width / clear passage width
- LDH Clear passage height / clear passage height
- FFL Finished floor level
- OW Opening angle 180°
- SF Fixed leaf
- GF Traffic leaf

### Please note:

- \* LDH for side door without threshold single-leaf + 15 mm, double-leaf + 20 mm
- \*\* Recess on location in the area of the U-shaped latching bolt

## Fitting variants side doors

### External fitting opening outwards

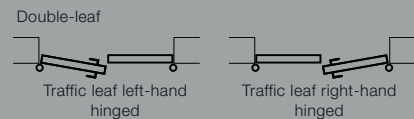
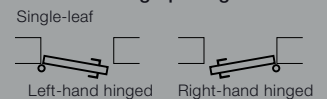

### Internal fitting opening inwards

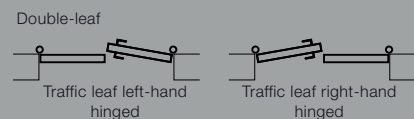
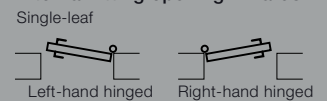

With doors fitted on the inside, the threshold angle or transport angle must always be removed and a water run-off to the outside must be provided. Doors on the weather side are preferably fitted externally.



# Experience Hörmann quality in new construction and modernisation

Hörmann provides an excellent basis for comprehensive planning. Carefully matched solutions offer you the very best in perfectly designed products for every area.

- **Garage doors**

Optimally match your personal architectural style: up-and-over or sectional doors made of steel or timber.

- **Door operators**

Enjoy extra convenience and break-in-resistant security with Hörmann operators for garage doors and entrance gates. You can profit from the convenience of Hörmann door operators in your residential space as well.

- **Entrance doors**

Our comprehensive entrance door ranges include models that fit almost every need and requirement.

- **Steel doors**

Sturdy doors for your entire home, from basement to roof.

- **Frames**

Choose from our comprehensive range of products for new construction, expansion and modernisation.



Garage doors and entrance gate operators



Thermo65 / Thermo46 entrance door



Steel doors

# Hörmann: Quality without Compromise



Hörmann KG Amshausen, Germany



Hörmann KG Antriebstechnik, Germany



Hörmann KG Brandis, Germany



Hörmann KG Brockhagen, Germany



Hörmann KG Dissen, Germany



Hörmann KG Eckelhausen, Germany



Hörmann KG Freisen, Germany



Hörmann KG Ichttershausen, Germany



Hörmann KG Werne, Germany



Hörmann Alkmaar B.V., Netherlands



Hörmann Legnica Sp. z o.o., Poland



Hörmann Beijing, China



Hörmann Tianjin, China



Hörmann LLC, Montgomery IL, USA



Hörmann Flexon LLC, Burgettstown PA, USA



Shakti Hörmann Ltd., India

Hörmann is the only manufacturer worldwide that offers you a complete range of all major building products from one source. We manufacture in highly-specialised factories using the latest production technologies. The close-meshed network of sales and service companies throughout Europe, and activities in the USA and Asia, make Hörmann your strong partner for first-class building products, offering "Quality without Compromise".

**GARAGE DOORS**  
**OPERATORS**  
**INDUSTRIAL DOORS**  
**LOADING EQUIPMENT**  
**HINGED DOORS**  
**DOOR FRAMES**

**HÖRMANN**