



## RollMatic rolling grille

Compact design perfect for store grilles in confined spaces.

**HÖRMANN**

## Innovative technology

Details perfectly matched to each other



### Compact design in two curtain variants

Thanks to its compact design with a max. required headroom or fitting depth of 335 mm, the new RollMatic rolling grille is the ideal solution for store grilles in confined spaces. Two curtain variants can be selected. Both versions are available in many RAL colours. The HG-L is additionally available in a brightrolled finish. Find the perfect rolling grille colour for a harmonious overall appearance.



**Only from Hörmann**



Lockable bottom profile



Shootbolt

## Manually operated or with operator

Operated via a pull chain or pull cord for manual operation, or automatically with an operator. Due to the power limit feature as standard, neither a closing edge safety device nor a lintel trap guard must be installed. The operator is integrated in the shaft cover for a compact design. The required sideroom for the door is only 110 mm or 210 mm on the operator side.

## Reliable and safe

The door can easily be operated by hand due to the tried and tested tension spring assembly. On doors with operators, this technology supports the operator during opening and closing. Double cabling additionally protects the door from crashing to the floor.

## Break-in-resistant fastening

The standard pull-out stops on the side ends of the curtain reliably keep the door in the side guide. They therefore protect the rolling grille curtain against attempts to push the curtain out of the side guide and provide break-in-resistance.

## Securely locked

Manually operated rolling grilles can be securely locked with a lockable bottom profile with profile cylinder, and can be actuated either from the interior or exterior. Alternatively, the grille can also be locked using a shootbolt. For doors with operators, the operator prevents the curtain from opening. Additional security is also provided by the lockable bottom profile and the shootbolt.

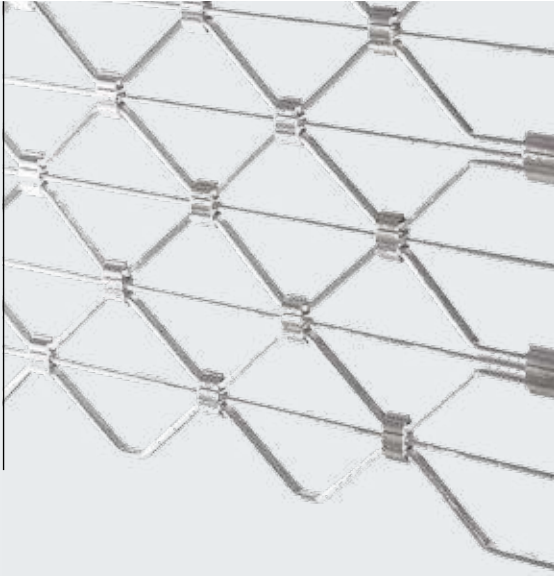

**HG-L, lightweight and compact aluminium**

The elegant and space-saving aluminium version is particularly suitable for use in shopping arcades. We offer bright-rolled or powder-coated surface finishes.

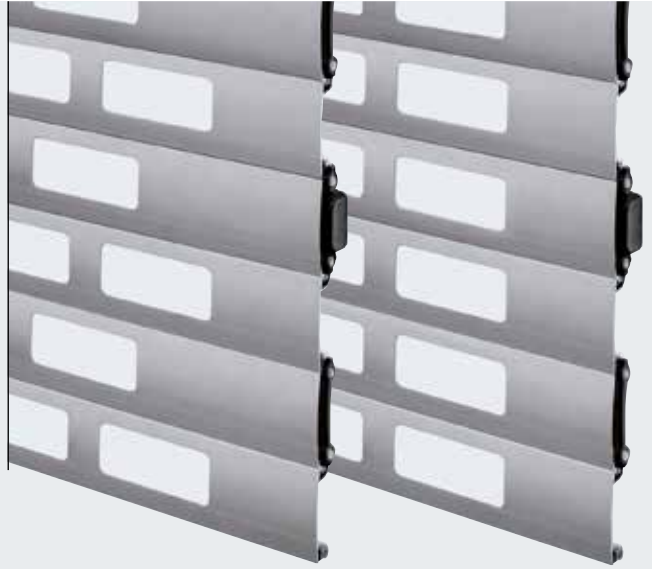

**HG 75, aluminium**

The extruded aluminium profiles are available in a powder-coated surface finish. The 100 × 40 mm square holes can be provided in a straight or offset arrangement.

<b>Curtain type</b>	<b>HG-L</b>	<b>HG 75</b>
<b>Size range</b>		
<b>Width up to</b>	4000 mm	4000 mm
<b>Height up to</b>	3100 mm	3000 mm
<b>Material</b>	Aluminium	Aluminium
<b>Surfaces without colour coating</b>	Bright-rolled	
<b>Surfaces with colour coating</b>	Colour coating RAL to choose	RAL 9016, RAL 7035, RAL 9006, RAL 5011, RAL 8028, RAL 7016, RAL 9005
<b>Weight of curtain</b>	Approx. 6.5 kg/m <sup>2</sup>	Approx. 6.5 kg/m <sup>2</sup>

# Fitting dimensions / size ranges

## RollMatic rolling grille

### Fitting behind the opening

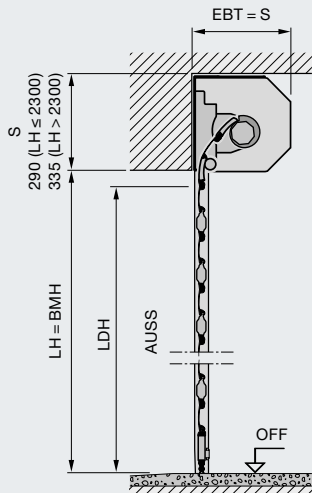
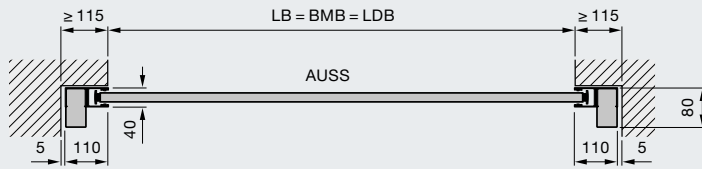
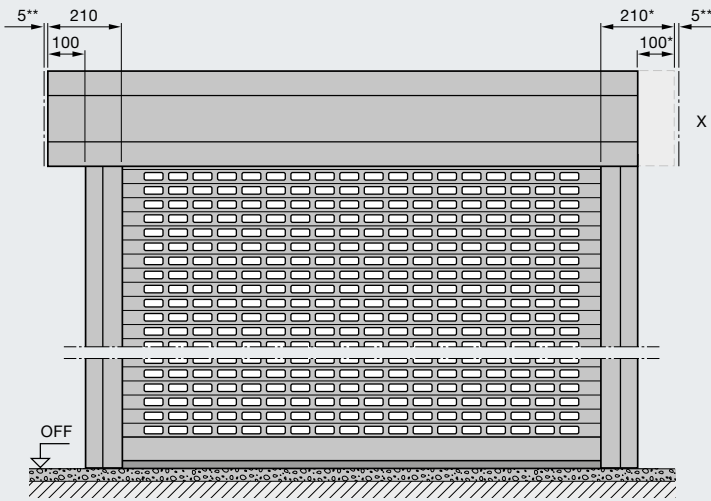

### Explanation of dimensions

BMB	Ordering size width
BMH	Ordering size height
LB	Clear width
LDB	Clear passage width = ordering size
LH	Clear height
LDH	Clear passage height = ordering size
EBT	Fitting depth
S	Required headroom
OFF	Finished floor level
AUSS	Exterior

### Fitting depth EBT

Up to 2300 mm door height	290 mm
From 2301 mm door height	335 mm

### Required headroom S

Up to 2300 mm door height	290 mm
From 2301 mm door height	335 mm

### Clear passage

Width	LB
Height (with operator)	LH - 60 mm
Height (manually operated)	LH - 125 mm
Height (with lockable bottom profile or shootbolt)	LH - 125 mm

### Side space requirement

Operator side	110 mm
Other side	210 mm



### X Shaft cover

\* A symmetrical arrangement is also possible, in addition to a variable operator position (as standard on the left, optionally on the right) with projection of the shaft cover on the operator side.

\*\* Min. side distance 5 mm

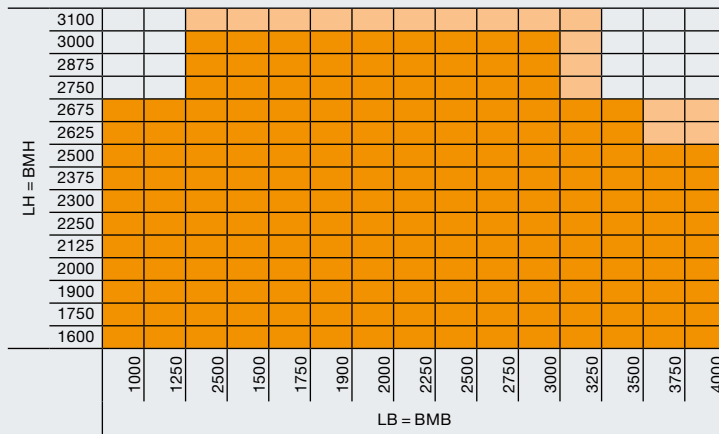
### Size range



	Size range for HG 75
	Size range for HG-L

Dimensions in mm

# Hörmann: Quality without Compromise



Hörmann KG Amshausen, Germany



Hörmann KG Antriebstechnik, Germany



Hörmann KG Brandis, Germany



Hörmann KG Brockhagen, Germany



Hörmann KG Dissen, Germany



Hörmann KG Eckelhausen, Germany



Hörmann KG Freisen, Germany



Hörmann KG Ichttershausen, Germany



Hörmann KG Werne, Germany



Hörmann Alkmaar B.V., Netherlands



Hörmann Legnica Sp. z o.o., Poland



Hörmann Beijing, China



Hörmann Tianjin, China



Hörmann LLC, Montgomery IL, USA



Hörmann Flexon LLC, Burgettstown PA, USA



Shakti Hörmann Pvt. Ltd., India

Hörmann is the only manufacturer worldwide that offers you a complete range of all major building products from one source. We manufacture in highly-specialised factories using the latest production technologies. The close-meshed network of sales and service companies throughout Europe, and activities in the USA and Asia, make Hörmann your strong partner for first-class building products, offering “Quality without Compromise”.

**GARAGE DOORS**  
**OPERATORS**  
**INDUSTRIAL DOORS**  
**LOADING EQUIPMENT**  
**HINGED DOORS**  
**DOOR FRAMES**

**HÖRMANN**